



Tools and Materials Needed

- Mitre saw (recommended) or hacksaw with non-ferrous metal cutting blade
- Level
- Measuring tape
- Wire rope cutters
- Adjustable wrench
- 3/16" Hex key
- Rotary tool with cutoff wheel for metal
- Drill
- Drill bits for wood: 1/4"
- Drill bits for metal: 1/8", 7/32"
- T40 Star driver bit
- Philips #2, #3 driver bits
- Non-corrosive exterior silicone caulking
- String line
- Vise grip pliers
- Anchoring fasteners (for concrete applications only)

Fasteners Supplied



1" Flat head screw



3/4" Pan head self-drilling screw



1-1/2" Pan head screw



3/4" Flat head screw



6" Self-drilling lag screw

Dear Customer,

We'd like to take a moment to say "thank you and congratulations" for choosing our products. At Peak® your satisfaction is very important to us. That is why we work very hard to provide you with products of exceptional quality, value, and beauty. And that is also why we want to hear from you.

Please contact us with your comments or suggestions at: cservice@peakproducts.com

Finally, we'd like to remind you to always work safely. Then, take pride, relax with your family and experience years of enjoyment with Peak® products.

The Peak Group of Companies

⚠WARNING

ALWAYS understand and COMPLY with your local building codes.

For use on single family residential structures ONLY.

Do NOT use on structures exceeding 3 stories.

Do NOT use where codes prohibit climbable guardrails.

Failure to maintain required cable tension may cause serious injury or death.

No representation or warranty is given that your particular application of these products complies with relevant building codes or that the fasteners provided or used are appropriate for your application. Consult with professionals and local building officials before beginning work: (i) to ensure compliance with relevant building codes for your application and for your proposed use of fasteners; (ii) to ensure the integrity of the structural components in connection with which these products are to be used; (iii) to identify appropriate safety gear that is to be used during installation such as a safety harness when working above ground; (iv) to ensure that the work area is free from utilities, services and hazards; and (v) to clarify any instructions or warnings that may not be clear. Work in a safe manner wearing protective gear such as gloves, eyewear, headwear, footwear and clothing. When using tools comply with operation manuals and instructions. Metal and glass may have sharp edges and could fragment or splinter during or as a result of handling or cutting. Do not use these products in connection with any substance that is or may be harmful or corrosive to the products. Inspect and maintain these products and the structural components that they are used in connection with on a regular basis, using professionals when appropriate.

No member of The Peak Group of Companies (as defined at www.peakproducts.com) shall be liable for any loss or damage resulting from the improper installation or use of this product. In the unlikely event that any member of The Peak Group of Companies becomes liable for any loss or damage, the aggregate liability shall be limited to the retail purchase price of the product. Peak products and associated materials are protected by patents, designs, copyrights and/or trademarks used under license from Peak Innovations Inc.

PCR_InstallGuide_US_V1

IMPORTANT INFORMATION

- Before beginning work, read this installation guide in its entirety including all warnings and important information.
- Throughout this installation guide, this symbol indicates important information: 

- This installation guide is updated occasionally. Please scan the QR code to refer to the latest version at:
<https://peakproducts.com/en-us/peak-cable-raili...on-guides-videos/>



- Always understand and comply with your local building codes.⁺
⁺Conditions apply. For details scan the QR code to visit:
<https://peakproducts.com/en-us/peak-cable-railing/compliance/>



- Maximum post spacing for Residential* use:
decks: 6' 0" stairs: 4' 4"
*Detached one- and two-family dwellings and townhouses not more than three stories above grade plane in height.
- Maximum length of 30' for a single cable between end posts.
- Peak® Cable Railing is designed for Residential¹ use only, and not for any commercial use.
¹ Detached one- and two-family dwellings and townhouses not more than three stories above grade plane in height.
- For multi-residential construction, please call Peak Customer Service at **1-877-883-PEAK (7325)** or email: cservice@peakproducts.com
- Stair Cable Railing Kits are designed for use on common stairs with an angle of 32° - 38°.
- To prevent wood splitting and rot, drill pilot holes and coat fastener screw threads with non-corrosive exterior silicone caulking.
- Cable tension should be checked and maintained at least once per year. To measure tension, it is recommended to use a cable (wire rope) tension gauge that is compatible with cable used in railings.
- For building code compliance (as shown in Figure 1 below):
A: Ensure the distance between end posts does not exceed 4".
B: Ensure the distance between vertical supports (posts or pickets) does not exceed 36".
C: Ensure the distance between horizontal cables and between a rail and a horizontal cable does not exceed 2-27/32".
D: Ensure the distance between stair cables, between the stair rail and the top stair cable, and between a stair cable and the stair nosing line, does not exceed 2-3/4".
E: Ensure the distance between stair posts does not exceed 52" measured along the stair angle.
F: Ensure cable tension on decks is maintained at 150 lbs.
G: Ensure cable tension on stairs is maintained at 220 lbs.

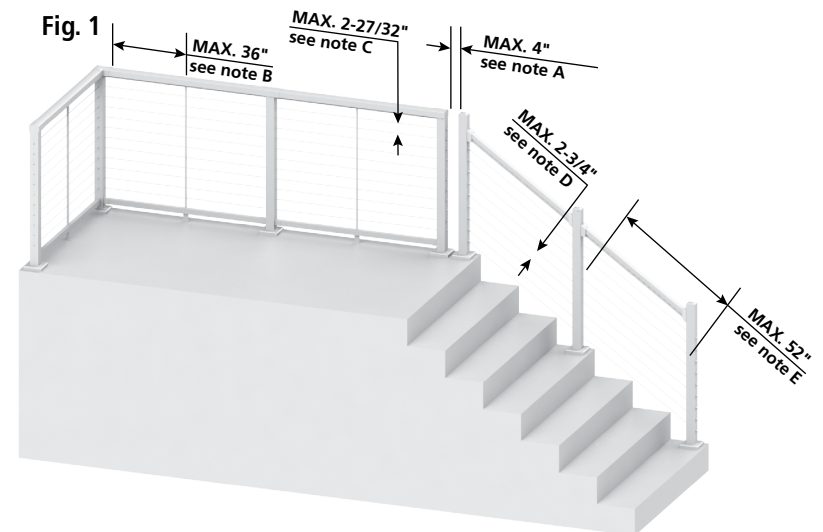

DECK INSTALLATION

- 1** Measure and mark the position of all posts and space equally.
- !** Maximum post spacing of 6' for Residential* use. For commercial use including multi-residential housing, please call Peak Customer Service at 1-877-883-PEAK (7325) or email: cservice@peakproducts.com
 - *Detached one- and two-family dwellings and townhouses not more than three stories above grade plane in height.

Put the first post in position. For wood attachment, install four 6" self-drilling lag screws through each corner of the post base. Ensure that the post is plumb.

- !** To prevent splitting of deck boards, drill four 1/4" pilot holes through deck boards (but not into deck structure).
- !** To prevent wood rot, coat fastener screw threads with non-corrosive exterior silicon caulking.
- !** For concrete attachment, please purchase fasteners separately.

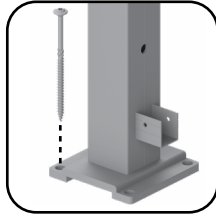

- 2**
- A:** Remove the spacer from the base rail.
 - B:** Temporarily position the second post but do NOT secure it yet. Cut the hand and base rails to fit between the posts.
 - !** If the spacing between the posts does not exceed 36", then it is not necessary to remove the spacer from the base rail before cutting to length.

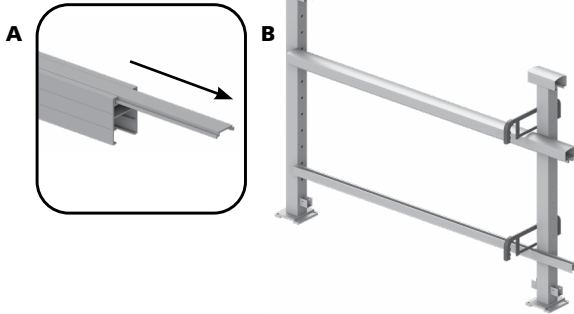

- 3**
- !** Only complete this step for rails longer than 36".
 - A:** Insert base rail support into base rail. Position it approximately at the centre.
 - B:** Determine cut length of base rail spacer by measuring base rail length, divide by 2, then subtract 5/32". Cut spacer to calculated length.
 - C:** Install the cut spacer into the base rail. Keep remaining spacer piece for later installation.

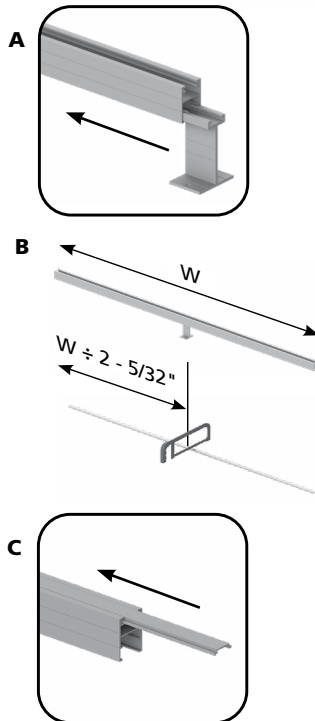

- 4** Insert the rails into the first post. Then insert the rails into the second post but do not secure it yet.
- A:** Secure the handrail to the first post with 3/4" pan head self-drilling screws.
 - B:** Secure the base rail to the first post with 3/4" pan head self-drilling screws.
 - C:** Install picket bracket onto top of picket.
 - D:** Place bottom of picket into base rail and tilt the top of the picket (with bracket) into the handrail track. Ensure the picket is plumb. The spacer should be tight to the first post, and the picket bottom should be touching the spacer in the middle of the base rail.
 - E:** Secure picket bracket in place with two 3/4" pan head self-drilling screws.

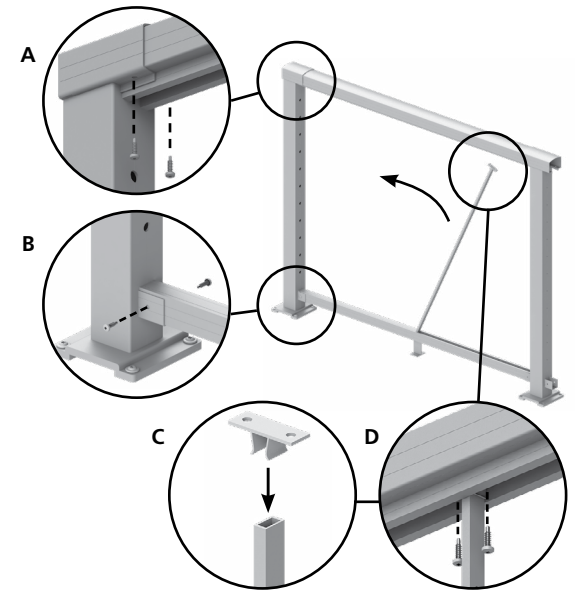

- 5**
- A:** Remove second post.
 - B:** Slide remaining spacer piece into base rail. Cut the spacer flush with the end of the base rail.

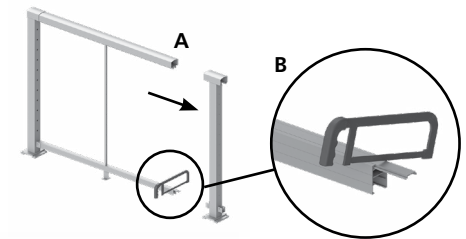

- 6**
- A:** Insert the rails into the second post.
 - B:** Position and fasten the second post in place, ensuring that the post is plumb (see step 1 for full details).

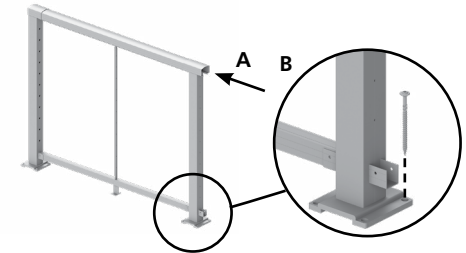

7

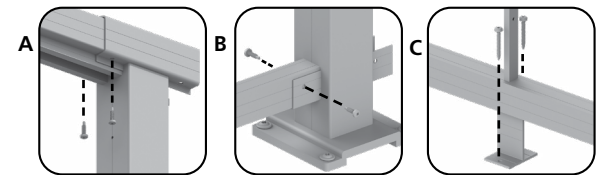

- 8** Install the post base covers. Repeat all steps for remaining sections.

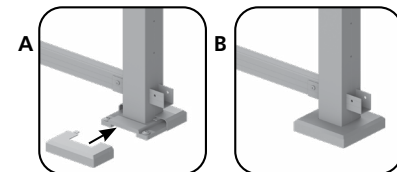

- 9** A: Set the length of adjustable fittings to 4-1/8".
 B: Feed cable through holes of all posts and install into fitting. Ensure cable end is tightly wound (no loose strands) before pushing into fitting.

⚠ Ensure plastic ring is slid onto the fitting before inserting the cable.

- C: Pull Adjustable Fitting back through holes in post.
 D: Cut cable using wire rope cutters so that 1' remains hanging from other end.

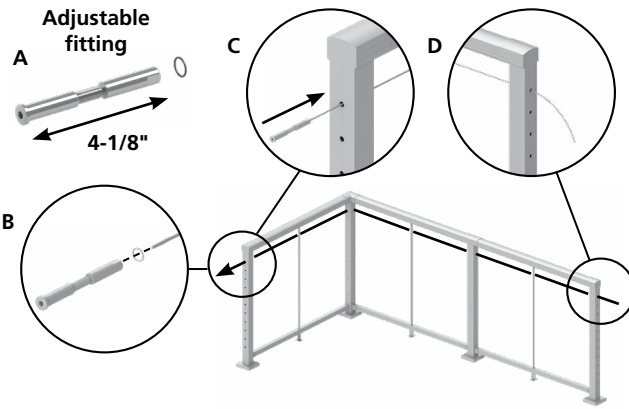

- ⚠ If needed, a cable release key is included with all hand and base rails. Place the release key on the cable with the small end toward the fitting, push key inward, then pull cable out while key is engaged.

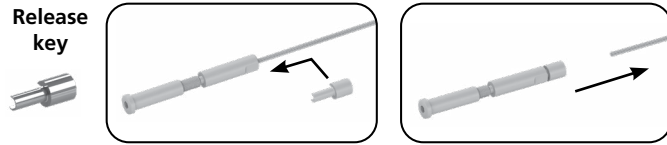

- 10** ⚠ For Corner Post Installation only:

- A: Feed the lacing tool (provided) through corner post holes.
 B: Insert cable securely within one end of the lacing tool.
 C: Push the cable to thread it around the corner, then remove the lacing tool and repeat for remaining cables.

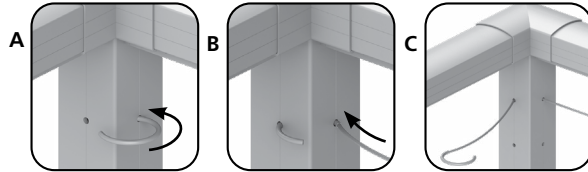

- 11** A: Install non-adjustable fitting onto loose end.

⚠ Ensure plastic ring is slid onto the fitting before installing onto cable

- B: Slide non-adjustable fitting along cable into end post hole.

⚠ Pro-tip: use vise-grip pliers leveraged on a block of wood to apply maximum tension by hand.

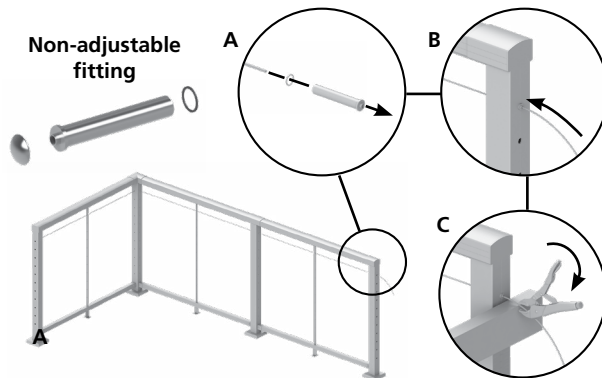

- 12** Repeat for all cables.

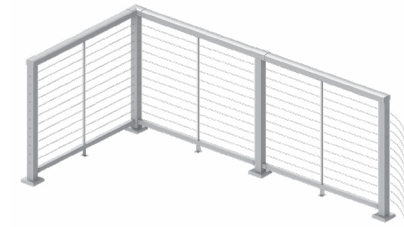

- 13** Starting at the middle and then alternating outward, tension cables to required 150 lbs using 3/16" hex key and adjustable wrench. Multiple passes may be needed. Repeat until all cable are at required tension.

36" Height Railing

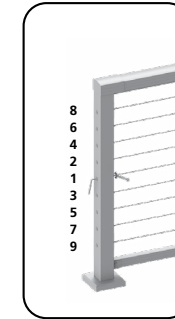

42" Height Railing

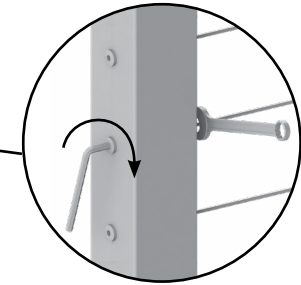
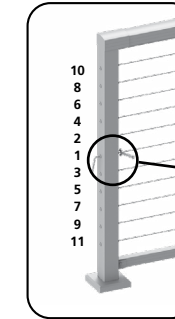

- 14** A: Use rotary tool with cutoff wheel to cut excess cable flush with the end of the non-adjustable fitting.

⚠ Take care not to damage the post with the grinder.

- B: Install cable fitting cap.
 C: Repeat for all cables.

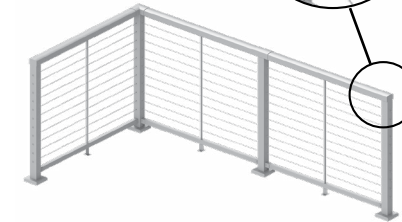
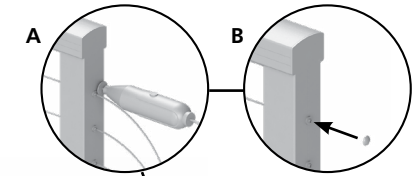

STAIR INSTALLATION

- 1** Measure and mark the position of all posts and space equally.
- ⚠ Maximum post spacing of 4' 4" for Residential* use. For commercial use including multi-residential housing, please call Peak Customer Service at 1-877-883-PEAK (7325) or email: cservice@peakproducts.com
 - *Detached one- and two-family dwellings and townhouses not more than three stories above grade plane in height.

Put the first post in position. For wood attachment, install four 6" self-drilling lag screws through each corner of the post base. Ensure that the post is plumb.

- ⚠ To prevent splitting of deck boards, drill four 1/4" pilot holes through deck boards (but not into deck structure).
- ⚠ To prevent wood rot, coat fastener screw threads with non-corrosive exterior silicon caulking.
- ⚠ For concrete attachment, please purchase fasteners separately.



- 2** A: Position mid and bottom posts on stairs. Pull a string line tight through bottom holes of each stair post. Adjust post positions to ensure string remains straight and parallel with stairs.

- ⚠ Ensure Stair End Posts are used at the top and bottom, and Stair Mid Posts are used between.

B: Secure remaining posts to stairs. Ensure each post is plumb. (See Step 1 for full details).

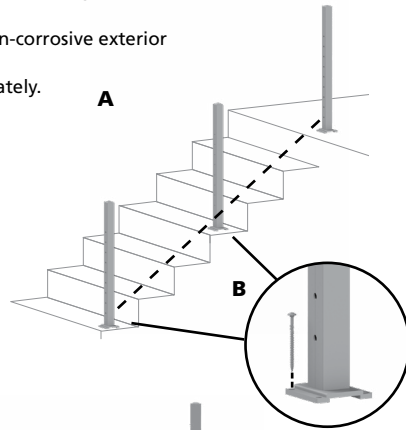

- 3** Position stair rail between posts by resting on stair treads. Mark vertical lines 3/8" from each end. Cut rail at marked lines.

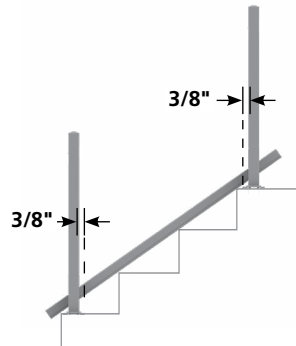

- 4** A: Mark horizontal line on top end post 2-3/4" on center from top cable hole.
 B: Position top rail bracket with bottom edge on the marked line. Mark hole positions.
 C: Drill 7/32" holes at marked positions.
 D: Secure bracket to post with 1" flat head screws.

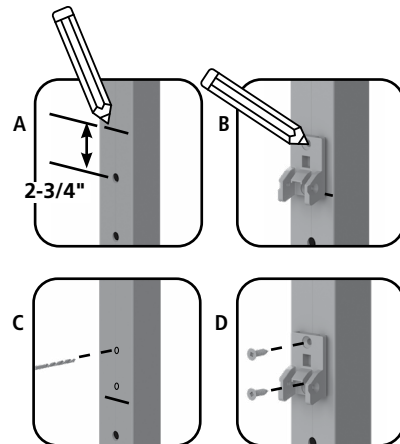

- 5** A: Temporarily position rail in upper bracket and set rail parallel with stair angle.

- ⚠ Ask a helper to hold the rail while the rail height and angle are being measured and adjusted.

B: Temporarily position and hold lower bracket on end of rail against lower post.

C: Remove rail and mark hole positions of lower bracket.

D: Drill 7/32" holes then secure lower bracket with 1" flat head screws.

- ⚠ Always understand and comply with your local building codes for stair rail height.

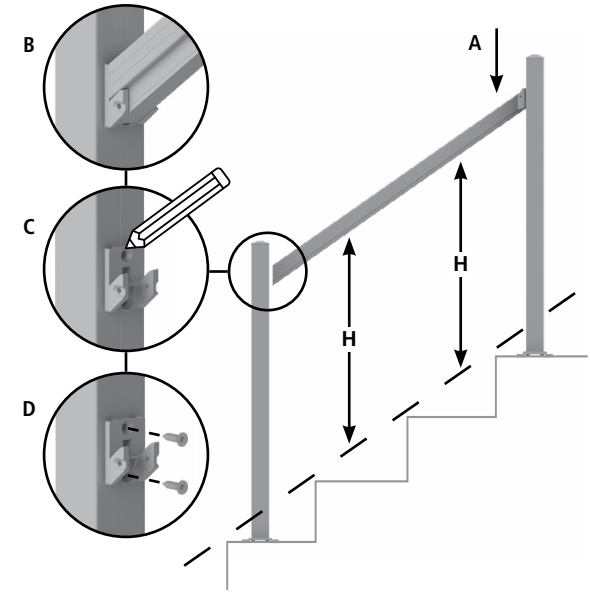

- 6** A: Reposition the top rail, then drill 1/8" pilot holes through the rails at the screw positions.

B: Attach the top rail to the brackets and secure with 3/4" flat head screws.

C: Slide a screw cover over each bracket.

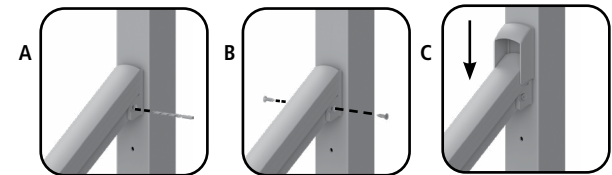

- 7** Repeat steps 5 & 6 for all remaining rails.

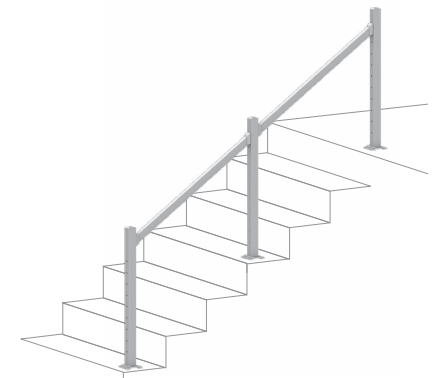

- 8** **A:** Set the length of adjustable stair fittings to 4-5/8".
B: Feed cable through holes of all posts and install into fitting. Ensure cable end is tightly wound (no loose strands) before pushing into fitting.

⚠ Ensure beveled washer is slid onto the fitting before inserting the cable.

- C:** Pull Adjustable Stair Fitting back through holes in post.
D: Cut cable with wire rope cutters so that 1' remains hanging from other end.

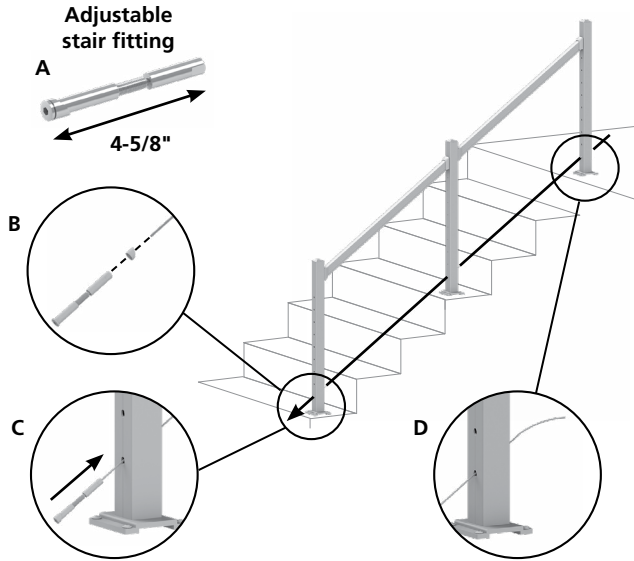

- ⚠** If needed, a cable release key is included with all stair rail kits. Place the release key on the cable with the small end toward the fitting, push key inward, then pull cable out while key is engaged.

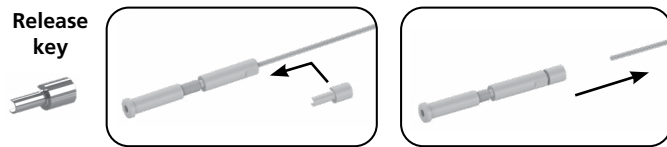

- 9** **A:** Install non-adjustable stair fitting onto loose end.
⚠ Ensure beveled washer is slid onto the fitting before inserting the cable.
B: Slide non-adjustable fitting along cable into end post hole.
C: Pull cable tight by hand.
⚠ Pro-tip: use vise-grip pliers leveraged on a block of wood to apply maximum tension by hand.

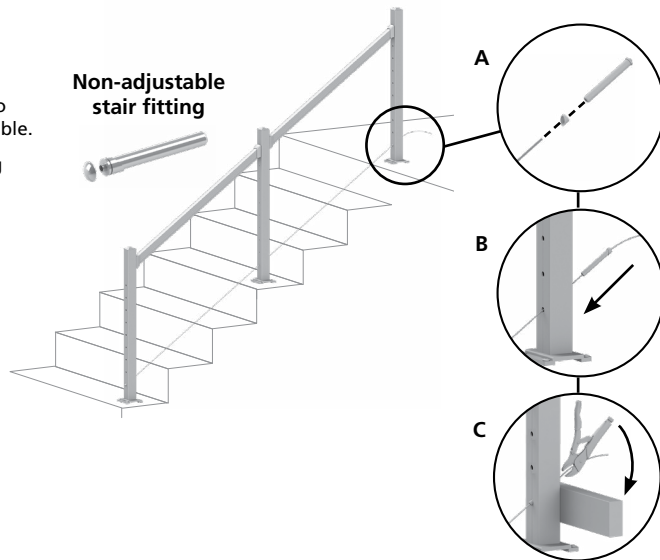

- 10** Repeat for all 9 cables.

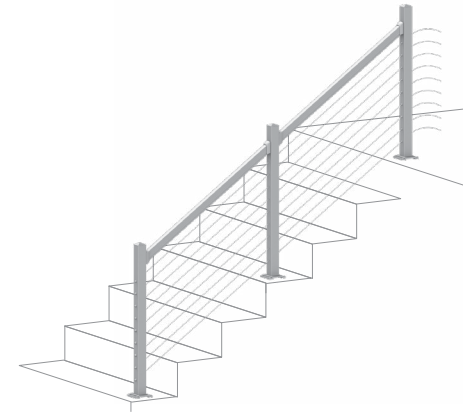

- 11** Starting at the middle and then alternating outward, tension cables to required 220 lbs using 3/16" hex key and adjustable wrench. Multiple passes may be needed. Repeat until all cable are at required tension.

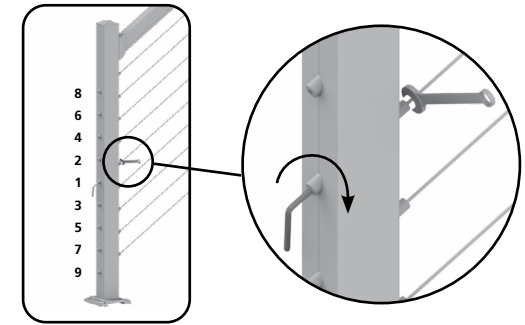

- 12** **A:** Use rotary tool with cutoff wheel to cut excess cable flush with the end of the non-adjustable fitting.
⚠ Take care not to damage the post with the rotary tool.
B: Install cable fitting cap.
C: Repeat for all 9 cables.

